

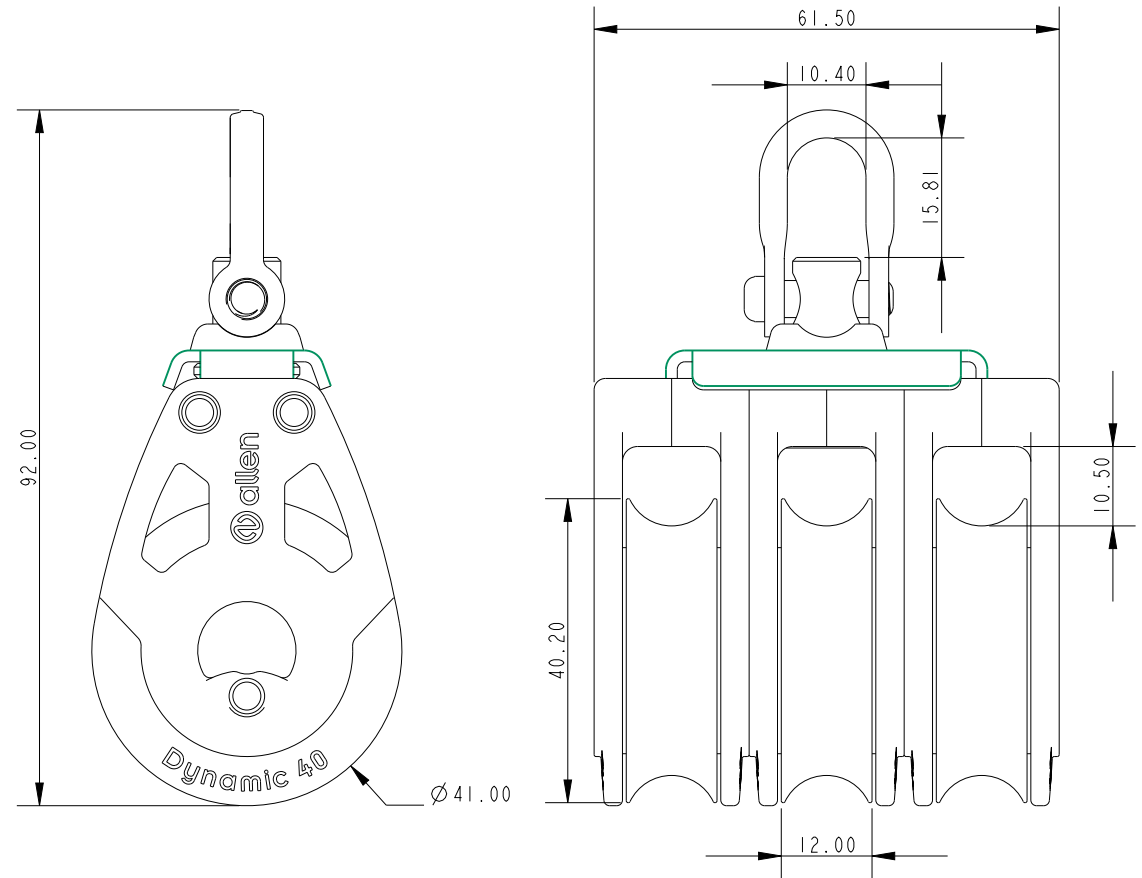

SCALE 1:1



Specification

Length mm	Line Diameter mm	Shackle Pin mm	Breaking Load kg	MWL kg	Weight g
92.00	10	5	1400	750	161

DIMENSIONS FOR REFERENCE ONLY
allenbrothers.co.uk
+44(0)1621 772477

Title	Description
A20403-REF	Triple